

FRONT LOADING



**110v Washer
TRW 620**

Owner's Manual

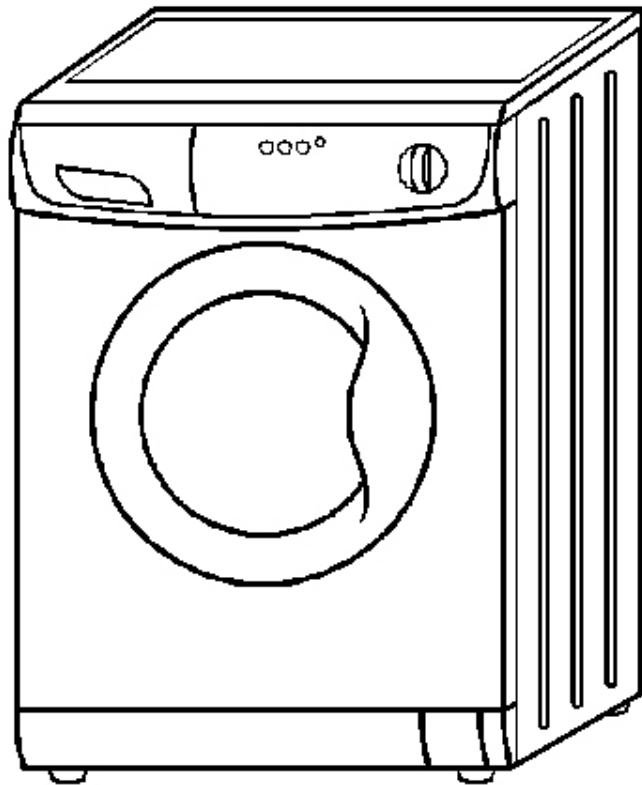

TABLE OF CONTENTS

Warranty.....	2-3
Introduction	4
Important Safety Instructions	5-6
Introduction & Pre installation.....	7
Picture of the Combo Washer	8
Installation	9-11
Control Panel	12-13
Operating Instructions	14
Program Selection Chart	15
Stain removal Chart	16-17
Winterizing washer.....	18
Maintenance & Technical Data.....	19
Troubleshooting.	20-21
Company Information	22

**Please read the Owner's Manual carefully before using your
New Triton Washer**

WARRANTY INFORMATION

Your TRITON Appliance is protected by this warranty under normal, personal, family or household use for 1 year (Parts & Labor) and limited commercial use (90 days) in the USA and Canada.

WARRANTY

Manufacturer undertakes to the consumer-owner to repair or, at our option, to replace any part of this product which proves to be defective in workmanship or material under normal personal, family or household use, in the USA and Canada, for a period of one year from the date of original purchase. For commercial use, the product is warranted for a period of 90 days. During this period, we will provide all labor and parts necessary to correct such defect, free of charge, if the appliance has been installed and operated in accordance with Triton Appliances' written instructions with the appliance. Ready access to the appliance, for service, is the responsibility of the consumer-owner. Triton Appliances will not be responsible for the installation and uninstallation of the unit.

EXCLUSIONS

In no event shall Triton Appliances be liable for incidental or consequential damages or for damages resulting from external causes such as abuse, misuse, incorrect voltage or acts God. This warranty does not cover service calls, which do not involve defective workmanship or materials covered by this warranty or incorrect installation procedures. Accordingly, diagnosis and repair costs for a service call, which does not involve defective workmanship or materials, will be the responsibility of the consumer-owner.

Specifically, the following work is not covered under warranty and does not constitute warranty work:

- **Installation – e.g. improper hook-up or leveling or non-removal of shipping bolts**
- **Maintenance – e.g. cleaning of air and/or water filter**
- **Damage – e.g. replacing broken door handle / damage to cabinet or external parts.**
- **RV's / Boats – e.g. excessive movement caused by travel or movement of vehicle.**

Most work is covered. The defining factor is, has the machine malfunctioned (manufacturer is responsible) or has the customer omitted or done something to cause machine to malfunction (customer is responsible). Some States do not allow the exclusion or limitation of incidental or consequential damages, so the above limitation or exclusion may not apply to you.

REMOTE LOCATIONS

In case the area of service is in a remote location, Triton Appliances may have to request for the appliance to be taken to the nearest authorized service agent we can find in order to provide service.

WARRANTY SERVICE

This warranty is given by:

TRITON Appliances
2801 W Sam Houston Pkwy N, Suite 175
Houston, TX 77043-1611

Service under this warranty must be obtained by the following steps, in order:

Call a TRITON Appliances Authorized Service Agent (obtain number of nearest agent from your dealer or by calling TRITON Service at 1-(866) 914 - 6067). Under normal circumstances, Service will be provided during regular business hours (9:00 a.m. to 5:00 p.m. weekdays).

GENERAL

Since it is responsibility of the consumer-owner to establish the warranty period by verifying the original purchase date, TRITON Appliances recommends that a receipt, delivery slip or some other appropriate payment record be kept for that purpose. Remember to send in your Warranty Registration Card so that a proof of your purchase exists with TRITON Appliances. You can also register online or by calling TRITON Appliances Customer Service at 1-866-218-6902. This warranty gives you specific legal rights, and you may also have other rights, which vary from State to State.

Corporate Office

TRITON Appliances
2801 W Sam Houston Pkwy N, Suite 175
Houston, TX 77043-1611
Phone (866) 914 - 6067



European Testing Laboratories

US N°3094367 CANADA

The ETL Listed Mark is the legal equivalent to the UL and CSA Listed Marks

TRITON CONTACTS

Website:	<u>www.tritonappliances.com</u>
Service:	1-866-914 - 6067/ service@tritonappliances.com
Parts & Accessories:	parts@tritonappliances.com
Technical Support:	<u>techsupport@tritonappliances.com</u>

INTRODUCTION

Congratulations on your new Triton Washer. In addition to its award winning design, this is a highly sophisticated engineered product that will give you many years of satisfaction. Please take the time to read this Owner's Manual in order to understand the machine and get the best use out of your valuable purchase.

Here are some of the best reasons for buying your Triton Washer

1. Energy Savings

This appliance is engineered to provide valuable energy savings when compared to other washers.

2. Maintenance

Since the machine has a self-cleaning pump, this appliance needs no cleaning of lint after washing. Instead, there is a convenient coin trap.

3. Water Savings

This appliance uses little water per wash cycle far less than standard full-size top-loading washer.

4. Improved Operation

With high speed spin, more water is extracted.

5. Convenience

This appliance can be permanently installed and be made portable with casters and the faucet adapter kit (sold separately as accessories) where needed.

6. Better Clothing Appearance

This Washer has no agitator to damage your clothes so they look better and last longer.

7. Placement Options

The Washer's sleek design makes it a perfect appliance for any Kitchen or Laundry Room. Its compact size makes the Washer perfect for placement on each floor of your home.

IMPORTANT SAFETY INSTRUCTIONS

Your safety and that of you children

Your washing machine has been built in compliance with safety regulations, to protect you and all your family.

WARNING - To reduce the risk of fire, electric shock, or injury to persons when using your appliance, follow basic precautions, including the following:

1. Read all instructions before using the appliance.
2. Do not wash articles that have been previously cleaned in, washed in, or spotted with gasoline, other flammable or explosive substances, as they emit vapors that could ignite or explode.
3. Do not allow children to play on or in the appliance. Close supervision of children is necessary when the appliance is used near children.
4. Before the appliance is removed from service or discarded, remove the door.
5. Do not reach into the appliance if the tub or drum is moving.
6. Do not install or store this appliance where it will be exposed to the weather.
7. Do not tamper with controls.
8. Do not repair or replace any part of the appliance or attempt any servicing unless specifically recommended in the user-maintenance instructions or in published user-repair instructions that you understand and have skills to carry out.
9. Do not add gasoline, dry-cleaning solvents, or other flammable or explosive substances to the wash water. These substances give off vapors that could ignite or explode.
10. Under certain conditions, hydrogen gas may be produced in a hot water system that has not been used for 2 weeks or more. **HYDROGEN GAS IS EXPLOSIVE.** If the hot water system has not been used for such a period, before using a washing machine, turn on all hot water faucets and let the water flow from each for several minutes. This will release any accumulated Hydrogen.
11. Do not use fabric softeners or products to reduce static unless recommended by the Triton Appliances.
12. Check the Coin Trap every few months to remove any coins, buttons or similar size objects.

SAVE THESE INSTRUCTIONS

HELPFUL HINTS

Your Washer features three different speeds during the wash cycle. During the Cotton cycle the drum spins at 1,000 or 400 rpm depending on how you set it. During Permanent Press the drum spins at 500 rpm. During delicates, the drum spins at 400 rpm. When washing heavy cotton articles such as bath towels or jeans, be sure the “Towels-Sheets” washer setting is selected. The faster spinning will extract more water from these highly absorbent fabrics and reduce the degree of dampness as the machine goes into the drying mode. This will cut down on your drying time.

Use Liquid Fabric Softener. Fill the softener compartment up to the level marked. Using fabric softener fluffs out clothes immediately after the wash cycle. This helps speed drying time and reduces wrinkles.

Use high efficiency (HE) Detergent. This is recommended for all front-loading washers. It ensures there is no over sudsing, which may reduce the performance of your machine. If you have any problem obtaining high efficiency (HE) detergent, please call Triton Appliances or order it online through www.appliancedesk.com

When sorting laundry always take into consideration the quantity and type of fabric contained in the load. Highly absorbent fabrics such as those used in towels or jeans will absorb more water and become very heavy when saturated. If you notice that you are washing too many highly absorbent articles for a single load, separate them into smaller loads.

SAFETY



CAUTION



**RISK OF ELECTRIC SHOCK
DO NOT OPEN**

CAUTION: TO REDUCE THE RISK OF ELECTRIC SHOCK, DO NOT REMOVE COVER (OR BACK). NO USER SERVICABLE PARTS INSIDE. REFER SERVICING TO QUALIFIED SERVICE PROFESSIONALS.

The model number of this product may be found on the back of the unit; the serial number of the label affixed to the back of the unit.

You should note the model and serial numbers of this unit in the space provided. Retain this booklet as a permanent record of your purchase to aid in identification in the event of theft.

MODEL# _____

SERIAL# _____

INTRODUCTION

Your new appliance is carefully engineered product. Many times what appears to be a reason to call service, the problem may require nothing more than a simple adjustment you can easily make in your own home.

You will be charged for a service call while the appliance is in warranty if the problem is not caused by defective product workmanship or materials covered by this warranty.

To avoid a charge for an unnecessary service call, and before calling a serviceman, please refer to the troubleshooting section for situations that you can remedy. This section is included on pages 20 of this Owners Manual.

Your Washer is front loading, with an extra large door opening for easier access. **It has 10 wash programs**

You will obviously want to obtain the best possible wash. By reading and following the instructions in this booklet you will achieve excellent results.

Please, ensure that the instructions are followed. If you should need any further advice or assistance, please, contact the dealer where your machine was purchased, or contact Customer Service at custserv@appliancedesk.com

This appliance is an automatic washer with a capacity of up to:

WASH 14 Lbs

PRE-INSTALLATION

1. The unit must be installed on a strong level floor, and in protected, dry, and well-ventilated area close to a power and water supply of sufficient capacity, and a sufficient outlet.

2. Installation on Carpet or Wood increases vibrations.

- Carpets - place on light carpet only.
- Wood - brace floor with screws and place additional sheets of plywood before installation.

3. This unit's installation and grounding should be done in accordance with local codes by a qualified installer. "Installation Instructions" are included in this manual for the Installer's reference.

4. The unit should be plugged into a properly grounded three (3) prong electrical outlet of 110 V/ 60Hz with minimum 15 amps. It should not be controlled by a wall switch or pull cord which might be turned off accidentally.

PICTURE OF THE WASHER

Detergent dispenser

Control Panel

Washer Knob

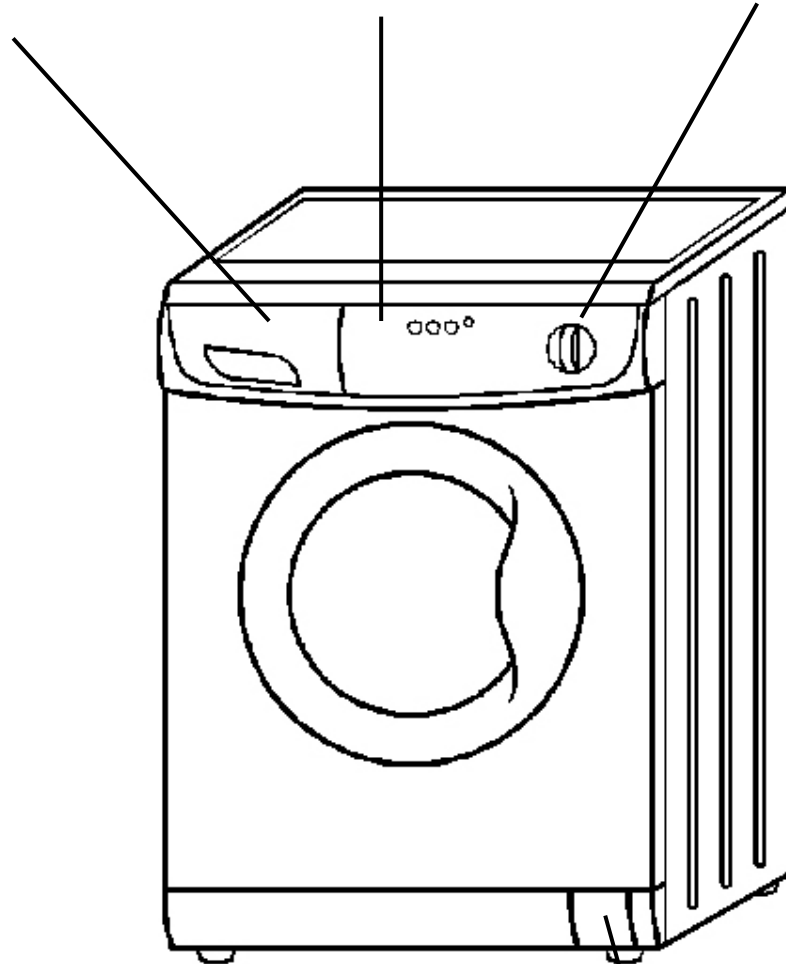

Adjustable Feet

Coin trap

INSTALLATION

UNPACKING, LEVELING, & POSITIONING

Remove the packing and check that the washer is undamaged. If you have any doubt, do not use the washer and call Triton Customer Service. Keep all packing parts (plastic bag, foam rubber, screws, etc.) out of the reach of children since they could be dangerous.

Important: The inside of the Washer consists of a free floating drum that is affixed with shipping bolts at the back of the cabinet (Fig.1) during transport. Before starting the machine, remember to remove the shipping bolts. Close the holes left open by the bolts with the plastic caps provided.

It is important for the machine to be perfectly level. For this reason, the machine is fitted with adjustable feet used for leveling the machine before use (Fig.2).

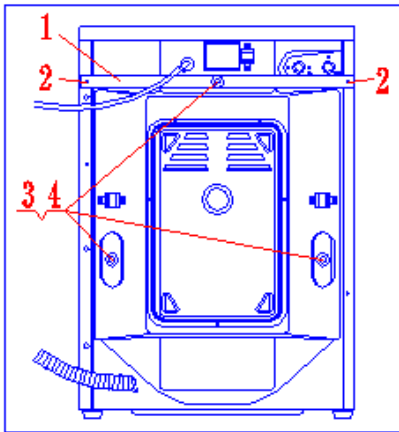

(Fig.1)

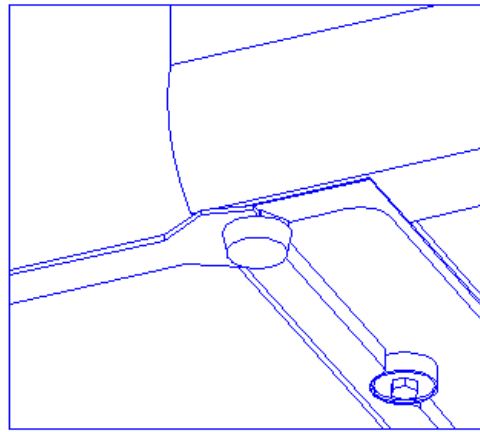

(Fig.2)

ELECTRICAL CONNECTION

Connect the plug to a power outlet – 110V/60Hz with minimum 15 amps. Make sure that the voltage and frequency available correspond with those stated on the serial number plate located on the machine. Do not use adaptors or extension cords since they could result in overheating and burn out.

GROUNDING

This appliance must be grounded. In the event of malfunction or breakdown, grounding will reduce the risk of electric shock by providing a path of least resistance for electric current. This appliance is equipped with a power cord having an equipment-grounding conductor and a grounding plug. The plug must be plugged into an appropriate outlet that is properly installed and grounded in accordance with all local codes and ordinances.

WARNINGS

- Improper connection of the equipment-grounding conductor can result in a risk of electric shock. Check with a qualified or service representative or personnel if you are in doubt as to whether the appliance is properly grounded.
- Do not modify the plug provided with the appliance: if it will not fit the outlet, have a proper outlet installed by a qualified electrician.

CONNECTING TO THE WATER FAUCET

Please read the following steps carefully (Fig.3, Fig.4)

1. Connect the *gray* end of the hoses supplied to the faucet (Fig.3).
2. Connect two pressure-reducing valves [2] to each inlet valve [1] (see Fig.4).
Note: Cold water hookup is needed for drying (Ventless models only).
3. Connect the *white* end of hoses to the pressure-reducing valve at the appropriate inlet valve (marked "H" or "C") (Fig.4).

CONNECTING THE DRAIN HOSE

Connect the drain hose to a drain duct (with internal diameter of at least 1.6 inches) or place it for drainage in to a sink or a tub, ensuring that there are no kinks or bends. The free end must be at a height of 31.5 inches from the floor, the hose must be fixed in the appropriate hook on the upper part of the back panel (Fig.4)

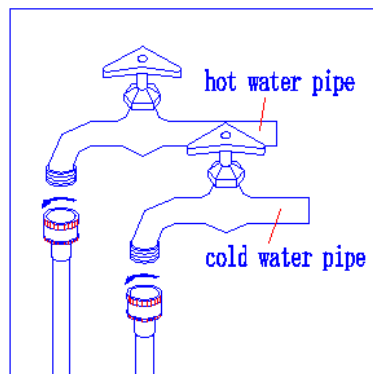

(Fig.3)

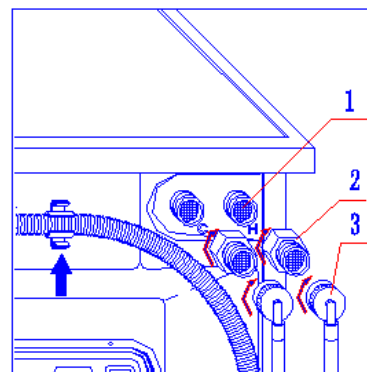

(Fig.4)

RECESSED, CLOSET AND ALCOVE INSTALLATION (Instructions)

The machine may be installed in a recessed area, closet or alcove.

The installation spacing is in inches and is the minimum acceptable.

Closet installation must be exhausted.

Other installations must use the minimum dimension indicated.

- Additional clearances for wall, door and floor molding may be required.
- Additional space is needed when an external exhaust elbow is used.

The closet's front door must be a shutter, and the clearance between the slats must be more than 1/3 area the front door (see Fig 5).

NOTE: If a door is installed that potentially encloses the unit while running, the door must allow for a minimum of 20 square inches of free air movement. There must also be a 1" space in front of the unit to the closed door and 1" from the back of the unit to the wall. Additional spacing should be considered for easy installation, servicing and compliance with applicable local, state, and federal codes.

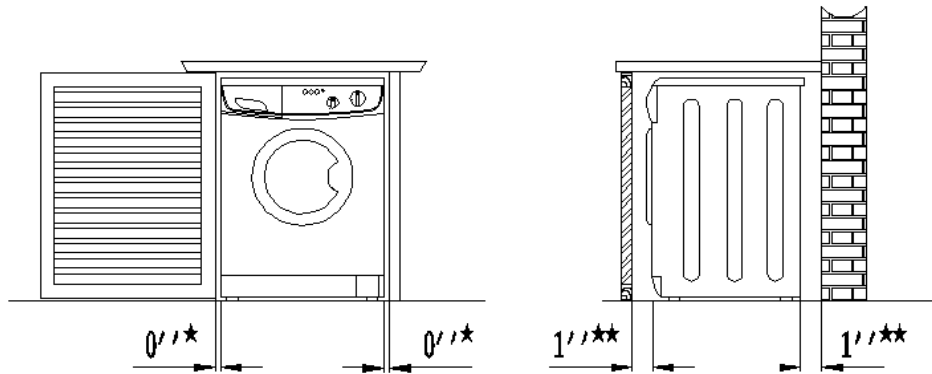

(Fig 5)

(Fig 6)

CONTROL PANEL

- A Wash program knob
- B Detergent Dispenser
- C Power button
- D ½ load button
- E No spin button
- F Power indicator light

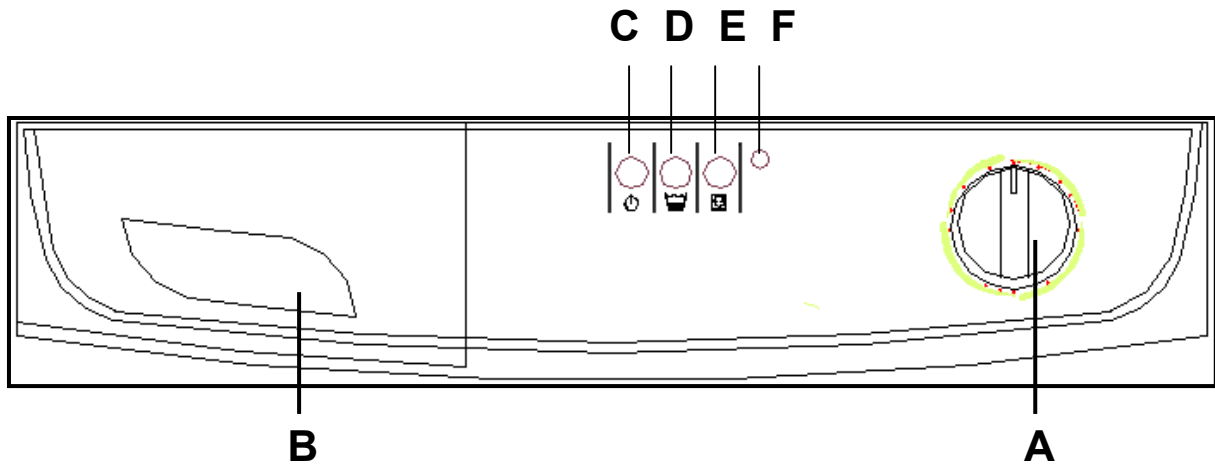

A Washer Program Knob

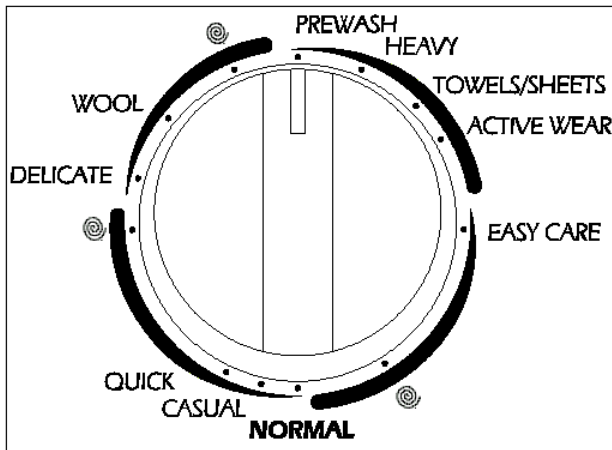

Turn wash program selector knob clock-wise, to choose wash cycle.

B Detergent Dispenser

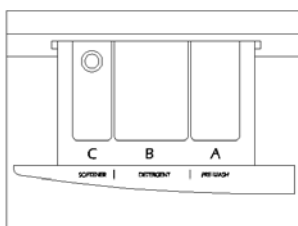

- The detergent dispenser has 3 compartments, marked A, B, C
- A Pre-wash detergent
 - B Wash detergent / Bleach
 - C Fabric softener (Downey)

C Power button.

Pressed in for ON
Not pressed for OFF

D 1/2 Load button.

If you have half a load or a light load, press this button.

E No spin button.

For delicate clothing (wools, silks etc.) Press this button for the, “Delicate” cycle and the washer drum will not spin.

F Power indicator light

This light indicates whether the power is on or off. The light comes on when button F is pressed and goes off when button F is not pressed.

Warning — to reduce the risk of fire, electric shock, or injury to person, read the **IMPORTANT SAFETY INSTRUCTIONS** before operating this appliance.

OPERATING INSTRUCTIONS

1. Make sure Washer is turned off. (Indicator light should be off).
2. Separate clothes into cottons, permanent press and delicates.
3. Close the Washer door. You will hear a click when it is correctly closed.
4. Add detergent to the center compartment of the dispenser (2). Use low-sudsing detergent – about 1 tablespoon. If desired, you can add pre-wash detergent, fabric softener and bleach as shown in the diagram.
5. Choose a Wash program by turning the wash selector knob clockwise to the desired setting on the control panel. (See chart on page 15)
6. If you have a light load or ½ load of clothes, press the ½ load button.
7. For delicates only (wool, silk, etc.) if you do not want the drum to spin, press the no spin button. Keep in mind that the clothes will retain a fair amount of water.
8. Review these steps and check all the settings on the control panel before starting the machine.
9. Press the Power button. The indicator light will come on and in a few seconds, you will hear the cycle begin.
10. When the Washer has completed the cycle, the machine will stop automatically, although the indicator light will remain on until you manually press out the Power button.

Note: The door switch of the Washer is electronic and locks automatically during the Wash cycle. You must wait for 2 minutes after the Wash cycle has stopped to open the door. Please do not try to force the door open. **Breaking of the door handle is not covered by warranty.**

STARTING THE WASHER

Starting your washer in the right way is important for the quality of your wash, to help prevent future problems and enhance life expectancy of your appliance. Once you have loaded your washer and added the detergent together with any fabric conditioner, **always check that:**

- 1) The door is closed correctly.
- 2) The plug is secured in the socket.
- 3) The water supply is turned on.

Choose the desired program

The program is selected according to the type of garments that need to be washed. To choose a program, refer to the table on page 15, then:

- 1) Turn **Washer** knob until the selected program is aligned with the mark on the knob,
- 2) If necessary use buttons ½ **LOAD** and **NO SPIN**
- 3) **Lastly**, press the **Power** button.

At the end of the wash cycle...

Turn the washer off by pressing **Power** button. You can now open the washer door safely. After having removed the freshly cleaned laundry, leave the door open to allow air circulation inside the drum. *Remember that, in the event of a power failure, or should the washer switch itself off, the program chosen will remain in memory.*

PROGRAM SELECTION CHART

Program	Description of load	Features	Suggested Drying heat and times
1 - Pre-wash	Heavy, soiled clothing	Prewash Cold water wash High spin	High heat 120 minutes
2 - Heavy	Thick cottons (towels, jeans)	Hot water wash High spin	High heat 90 minutes
3 - Towels/Sheets	Mixed cottons (t-shirts, jeans)	Warm water wash High spin	High heat 90 minutes
4 - Active Wear	Delicate colors	Cold water wash High spin	High heat 90 minutes
5 - Easy Care	Mixed cottons	Cold water rinse High spin	High heat 90 minutes
6 - Normal	Cotton mix, light fabrics	Warm water wash Medium spin	Medium or high heat – at least 60 minutes
7 - Casual	Cotton mix, light fabrics	Cold water wash Medium spin	Medium or high heat – at least 60 minutes
8 - Quick	Cotton mix, light fabrics	Cold water wash Medium spin	Medium or high heat – at least 60 minutes
9 - Delicates	Wools, silks	Cold water wash Low spin	No Dry cycle after Wash cycle ends
10 - Wools	Wools, silks	Cold water rinse Low spin	No Dry cycle after Wash cycle ends

USEFUL TIPS

Denim Alert:

Some overalls have straps with hooks that can damage the drum of your washing machine or other garments during the wash. To minimize the risk, place hooks in the pocket and fasten with safety pins.

Vacations: unplug the appliance:

It is recommended that you should unplug the machine from the socket and turn off the water supply. Leave the door ajar to allow air circulation to the drum and the door gasket area. This will prevent unpleasant odors.

STAIN REMOVAL CHART

Blood

Rinse or soak fresh stain in cold water. Work detergent into any remaining stain. Rinse. If stain persists, put a few drops of ammonia on stain and repeat detergent treatment. Rinse. If necessary bleach.

Candle Wax

Scrape off excess. Place stain between clean white blotters or several layers of facial tissues. Press with warm iron. Sponge with cleaning fluid. If dye spot remains, bleach.

Ketchup

Scrape off excess. Soak in cold water 30 minutes. Pre-treat with a detergent paste. Launder.

Chewing Gum

Rub with ice to harden. Scrape off excess with dull blade. Sponge with cleaning fluid.

Chocolate or Cocoa

Soak 15 minutes in cold water. Rub detergent paste into stain, then rinse thoroughly. Launder in hottest water safe for fabric. If colored stain remains, sponge with hydrogen peroxide, rinse and launder.

Cod liver Oil

Sponge article with cleaning fluid. Soak in warm suds. If stain persists, wash with bleach safe for fabric. To remove yellow stain, sponge with hydrogen peroxide. Rinse and launder. Old stains may be nearly impossible to remove.

Coffee or Tea (Black)

Soak fresh stains immediately in cold water. Then use bleach treatment with hottest water safe for fabric. Or if safe for the fabric pour boiling water through spot from a height of 1 to 3 feet. Launder.

Coffee or Tea (With Cream)

Rinse or soak in cold water. Work detergent into stain. Rinse. Dry. If grease stain remains, sponge with cleaning fluid. Repeat, if necessary. If stain remains, bleach.

Cosmetics: eye shadow, lipstick, liquid make-up, mascara, powder, pancake make-up or rouge

Apply undiluted liquid detergent to stain, or dampen stain and rub in soap or detergent paste until thick suds are formed. Work in until stain is gone, rinse well. Repeat if necessary. If color remains, bleach if safe for fabrics.

Cream, Ice Cream or Milk

Sponge stain with cool water or soak stain in cool water for 30 minutes or longer. If stain remains, work a detergent in- to spot then rinse. Bleach if necessary.

Deodorants and Antiperspirants

Wash or sponge stain thoroughly with warm water and detergent; rinse. If stain remains, bleach with hot sudsy water. Launder. You may be able to restore fabric color by sponging with ammonia. Rinse thoroughly.

Dye

Rinse or soak in cold water. Work detergent into stain. Rinse. If necessary, bleach. Stain is not always possible to remove. A commercial color remover may also be used.

Egg or Meat Juice

Rinse in cold water. If stain remains, sprinkle with meat tenderizer, let stand 15-20 minutes. If stain still remains, sponge with cleaning fluid or diluted bleach. Launder in hot water. The use of hot water first may set stain.

Fabric Softener Stain

Rub with bar soap until stain has lightened. Rinse thoroughly. Launder. Rubbing alcohol is sometimes effective in the color of the garment can take it. Launder. If desired, dry cleaning can be used.

Felt tip pen

Spray spot with cleaners suitable to this purpose. Sponge stain thoroughly. Rinse with cold water. Reapply cleaner if necessary.

Fruit, Wine

Soak fresh stains immediately with cool water. Then use bleach treatment with hottest water safe for fabrics, pour boiling water through spot from a height of 1 to 3 feet. Launder.

Grass

Work detergent into stain. Sponge with denatured alcohol. Bleach, if necessary.

Grease or Oil

Scrape away excess. Rub detergent paste or a general-purpose liquid household cleaner into stain, rinse with hot water. If stain remains, sponge thoroughly with a grease solvent. Dry. Repeat if necessary. To remove yellow stain, use chlorine or oxygen bleach.

Ink. Ball-point

Same ballpoint inks are set by water. First test a scrap of cloth. Sponge stain repeatedly with acetone, amyl acetate or rubbing alcohol. Hair spray is effective. Launder. Bleach if necessary. Use amyl acetate on triacetate, arnel, dynel and verel. Use acetone on other fabrics. NOTE: Some ink cannot be removed.

Mildew

Brush off surface growth to keep mold spores from spreading. Dip article into solution of 1/2-cup bleach per 1 gallon of cool sudsy water for 5 to 10 minutes. Rinse well. Launder.

Mud

Let stain dry; then brush well. Rinse repeatedly in cool water until mud comes out. Launder. (Hot soaps suds set a red or yellow clay stain).

Mustard

Soak in hot detergent water for several hours. If stain remains, bleach.

Nail Polish

Treat while fresh, scraping or wiping off as much as possible, before it dries. Place stain face down on white paper towels. Sponge back of stain acetone (nail polish remover) or sponge with denatured alcohol and a few drops of household ammonia. Sponge stain frequently. Launder with water at temperature suitable for fabric. *Do not use acetone on acetate, arnel, Dynel or rayon.*

Paint

Sponge or soak in turpentine or solvent recommended as a thinner on label. Launder.

Perfume

Rinse in cold water. Rub undiluted liquid detergent or a detergent paste into stain. Rinse. If stain remains, bleach.

Perspiration

Wash or sponge stain thoroughly with warm water and detergent paste. If perspiration has changed the color of the fabric, restore it by treating with ammonia or vinegar. Apply ammonia to fresh stains; rinse with water. Apply vinegar to old stains; rinse with water.

Rust and Iron

Apply commercial rust remover, according to manufacturer's directions. Rinse. Or, if safe for fabric, boil stained article in solution of 4 teaspoons of cream of tartar to 1 pint water.

Scorch

Rinse or soak in cold water. Work detergent into stain. Rinse. Bleach, if necessary. Stain may be impossible to re move

Shoe

Polish Scrape off as much as possible. Pre-treat with a detergent paste; rinse. If stain persists, sponge with rubbing alcohol (1 part to 2 parts water) or turpentine. Remove turpentine by sponging again with warm detergent solution or with alcohol. Bleach if necessary.

Soft Drinks

Sponge with cold water, some stains are invisible when they have dried, but turn brown when heated and may be impossible to remove.

Tar and Asphalt























Act quickly before stain is dry. Sponge with grease solvent or turpentine. Launder.

Urine

Soak in cool water. If stain is dry, work a detergent paste into the spot then rinse. If necessary, bleach.

UNDERSTANDING FABRIC CARE LABELS

The symbols on labels of your garments will help you in choosing the suitable wash program, the right temperature, wash cycles, and ironing methods. Don't forget to give a glance to these useful indications!

Machine Wash Cycle	 Normal/ Cotton Heavy Duty	 Permanent Press/ wrinkle resistant	 Delicate/ Gentle	 Hand wash	 Do not wash	 Do not wring
Water Temp.	 Hot (50°C/120°F)	 Warm (40°C/105°F)	 Cold/Cool (30°C/85°F)			
Tumble Dry	 Dry	 Normal/ Cotton Heavy Duty	 Permt Press/ wrinkle resistant	 Delicate/ Gentle	 Do not tumble dry	 Do not dry
Special Instructions	 Line dry/ hang to dry	 Drip dry	 Dry flat	 In the shade		
Bleach Symbols						

Select the right temperature...

Look !

WINTERIZING YOUR WASHER

To winterize your washer please, follow the instructions below to avoid damage to your unit due to freezing:

1. With the unit off, remove wash filter. This will allow the water remaining in the pump and drain hose to be evacuated. Replace filter.
2. **Close the inlet shut-off valves (provided by installer) and disconnect the inlet hoses. There should be no water in the hoses where they attach at the back of the machine.**

IF ANTIFREEZE IS BEING USED IN THE SYSTEM FOLLOW THESE INSTRUCTIONS:

(Not necessary if the above drain procedure is followed)

1. **When putting antifreeze into the water system of your coach, set the washer to a warm/warm fill setting and allow water to flow into unit until antifreeze is detected.**
2. Advance the knob timer on "Reset", turn on "Rinse" position and allow water to flow for 10 seconds.
3. **Advance the knob timer on "Reset" and then turn again on "Spin" to remove the majority of the water from the unit.**
4. With the unit off, remove wash filter from unit. This will allow the water remaining in the pump and drain hose to be evacuated. Replace filter.
5. **If you elect you may close the inlet shut-off valves (provided by installer) and disconnect the inlet hoses.**
6. Any water remaining in the unit should contain antifreeze and be protected from freezing.

Note: When placing unit into service allow unit to operate for one complete cycle before doing laundry to ensure all antifreeze has been purged from the unit.

If you have any further questions pertaining to this matter please contact **Technical Support Toll free at tech@appliancedesk.com**

MAINTENANCE

Your Washer has been designed to be operated without complicated maintenance.

Follow these simple maintenance procedures for good results:

1. Ensure that your machine was installed according to the correct installation procedures detailed in this Manual.
2. Do not use solvents either to clean the machine or to wash clothes.
3. Keep the inside of the detergent dispenser clean;
4. The drain pump of this Washer is a self-cleaning pump. It is therefore not necessary to carry out cleaning and maintenance operations. However, objects (such as buttons, coins, etc) may sometimes accidentally drop into the pump. Since these can't be expelled through the drain hose, please remove the cover panel at the bottom of the unit by holding down on the small tab and pulling the cover down (Fig. 6), remove the pump cover, and carefully inspect the inside. (Fig.7). Be sure to close the cover after cleaning. The tab should be gently pulled up until you hear a click.

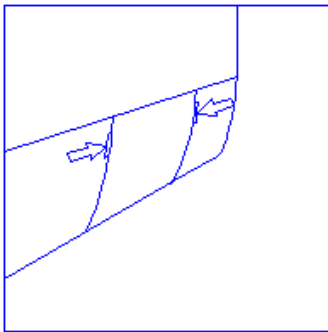

(Fig.6)

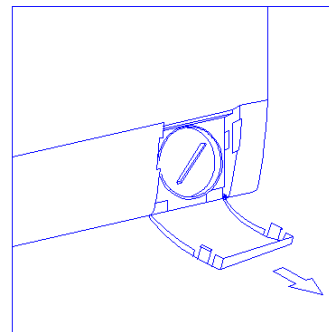

(Fig.7)

TECHNICAL DATA

Model	TRW 620
Rated Voltage	110-120V/60Hz
Washing input power	560W
Spin input power	980W
Capacity	14lbs.
Spin Speed	1,000 rpm
Wash programs	8
Water pressure	0.05-1(MPa)
Dimensions (HXWXD)	33.5 x 23.5 x 21.6 (inches)
Weight	167 lbs.

TROUBLESHOOTING

In most cases, when your washer fails to work, the problems arising can be easily solved without having to call for a technician. Before calling for assistance, always check these points.

➤ **The washer fails to start**

- Is the plug correctly inserted into the socket?
- Is there electricity in the house?
- Is the door closed properly?
- Is the power button pressed?
- Is the Washer knob in the correct position for the cycle to start?
- Is the water supply turned on?

➤ **The washer fails to fill with water**

- Is the hose correctly connected to the faucet?
- Is there water supply?
- Is there sufficient water pressure?
- Is the faucet filter clean?
- Is the inlet hose kinked?
- Is the Power Supply on?
- Is the door-closed properly/ tightly?

➤ **The washer continuously fills and drains water**

- Is the drain hose positioned too low?
- Check that the inlet hose is not connected at a height less than 24 inches above the floor.
- Is the end of the outlet hose immersed in water?

➤ **The washer does not drain or spin**

- Does the selected program incorporate water draining?
- Is the drain pump clogged?
- Remove foreign objects if any from the filter housing and clean the filter.
- Is the drain hose kinked or blocked?
- Is the drain hose positioned too high?
- Check that the Drain standpipe inlet is not more than 36 inches above the floor.

➤ **There are too many suds in the drum**

- Is low-sudsing detergent being used? It is recommended to use High Efficiency detergent.
- Is the correct amount of detergent being used?

➤ **The washer vibrates too much during the spin cycle**

- Have all shipping bolts been removed during installation?
- Has the machine been leveled correctly?
- Is there space between the machine and adjacent units?
- Is the machine loaded evenly?
- Is the machine installed on carpet or on a wooden floor?

➤ **The washer leaks**

Is the inlet hose properly attached?

Is the detergent dispenser obstructed?

Is the drain hose inserted correctly into the drain?

➤ **The washer door won't open**

Is the water in the drum completely drained out?

CONTACT INFORMATION

www.TritonAppliances.com

SERVICE & SUPPORT:
service@tritonappliances.com
(866) 914-6067

TRITON Appliances
2801 W Sam Houston Pkwy N, Suite 175
Houston, Texas 77043-1611
Phone (866) 914 - 6067
All rights reserved.
Manual subject to change without notice